



GACIA



P Product Information

GACIA







GACIA ELECTRICAL APPLIANCE CO., LTD.

Add: 545#Dongdajie, Beibaixiang, Baitawang Industrial Zone, Wenzhou Zhejiang, China







Tel: 86-577-62982555 Fax: 86-577-62983555

E-mail: gacia@gacia.com.cn [Http://www.gacia.com.cn](http://www.gacia.com.cn)



Model	PB8N	PB8H	PB8NN
IEC/EN 60898-1			
Poles	1P,1P+N,2P,3P,3P+N,4P	1P,1P+N,2P,3P,3P+N,4P	1P,1P+N,2P,3P,3P+N,4P
Certification			
Electrical Specification			
Rated current(A)	In	1-63	1-63
Rated frequency(Hz)		50/60	50/60
Rated working voltage(V)	Ue	1P:230/400~,2/3/4P:400~	1P:230/400~,2/3/4P:400~
Rate insulated voltage(V)	Ui	500	500
Impulse withstand voltage(kV)	Uimp	6	6
Rated short-circuit breaking capacity(kA)	Icn	6	10
Instantaneous tripping type		B,C,D	B,C,D
Maximum working voltage		440	440
Dielectric test voltage(kV)		2	2
Service life (O-C)	Mechanical	Standard value	10000
	Electrical	Standard value	4000
Control And Indication			
Shunt release(SHT)		<input type="checkbox"/>	
Undervoltage release(UVT)		<input type="checkbox"/>	
Auxiliary contact(AUX)		<input type="checkbox"/>	
Alarm contact(ALT)		<input type="checkbox"/>	
Contact position indicator		<input checked="" type="checkbox"/>	
Fault indication		-	
Connection And Installation			
Ambient temperature(with daily average≤35℃)		-5℃ ~+40℃	
Protection degree	ALL sides	IP40	
	Connection terminal	IP20	
Wire(mm ²)	1-16	1-16	1-16
busbar(mm ²)	25	25	25
Mounting	Cable/Busbar	Cable/Busbar	Cable/Busbar
Pollution degree		2	
Reference temperature for setting of thermal element(℃)		30	
Storage temperature(℃)		-25℃ ~+70℃	
Tightening torque		3.0	
Connection		Top and Bottom	
Dimensions(mm) (WxHxL)	a(1P/2P/3P/4P)	17.5/35/52.5/70	
	b(1P/2P/3P/4P)	87/87/87/87	
	c(1P/2P/3P/4P)	77.5/77.5/77.5/77.5	
Weight(kg)	1P	0.11	
	2P	0.22	
	3P	0.33	
	4P	0.44	

■ Default □ Optional - None

PB8HH	PN8N	PN8H
		
1P,1P+N,2P,3P,3P+N,4P	1P+N	1P+N
		
Electrical Specification		
1-63A	1-40	6-40
50/60	50/60	50/60
1P:230/400~,2/3/4P:400~	230~	230~
500	400	400
6	4	4
10	4.5	6
B,C,D	B,C,D	B,C,D
440	240	240
2	2	2
10000	10000	10000
4000	4000	4000
	<input type="checkbox"/>	
	<input type="checkbox"/>	
	<input type="checkbox"/>	
	<input type="checkbox"/>	
	<input checked="" type="checkbox"/>	
	-	
Connection And Installation		
	-5℃ ~+40℃	
Protection degree	ALL sides	IP40
	Connection terminal	IP20
1-16	1-10	1-10
25	-	
Cable/Busbar	Cable	Cable
	2	
	30	
	-25℃ ~+70℃	
3.0	2.5	
	Top and Bottom	
17.5/35/52.5/70	17.5(1P+N)	17.5(1P+N)
87/87/87/87	87(1P+N)	87(1P+N)
77.5/77.5/77.5/77.5	77.5(1P+N)	77.5(1P+N)
0.11	0.12(1P+N)	0.13(1P+N)
0.22	-	-
0.33	-	-
0.44	-	-

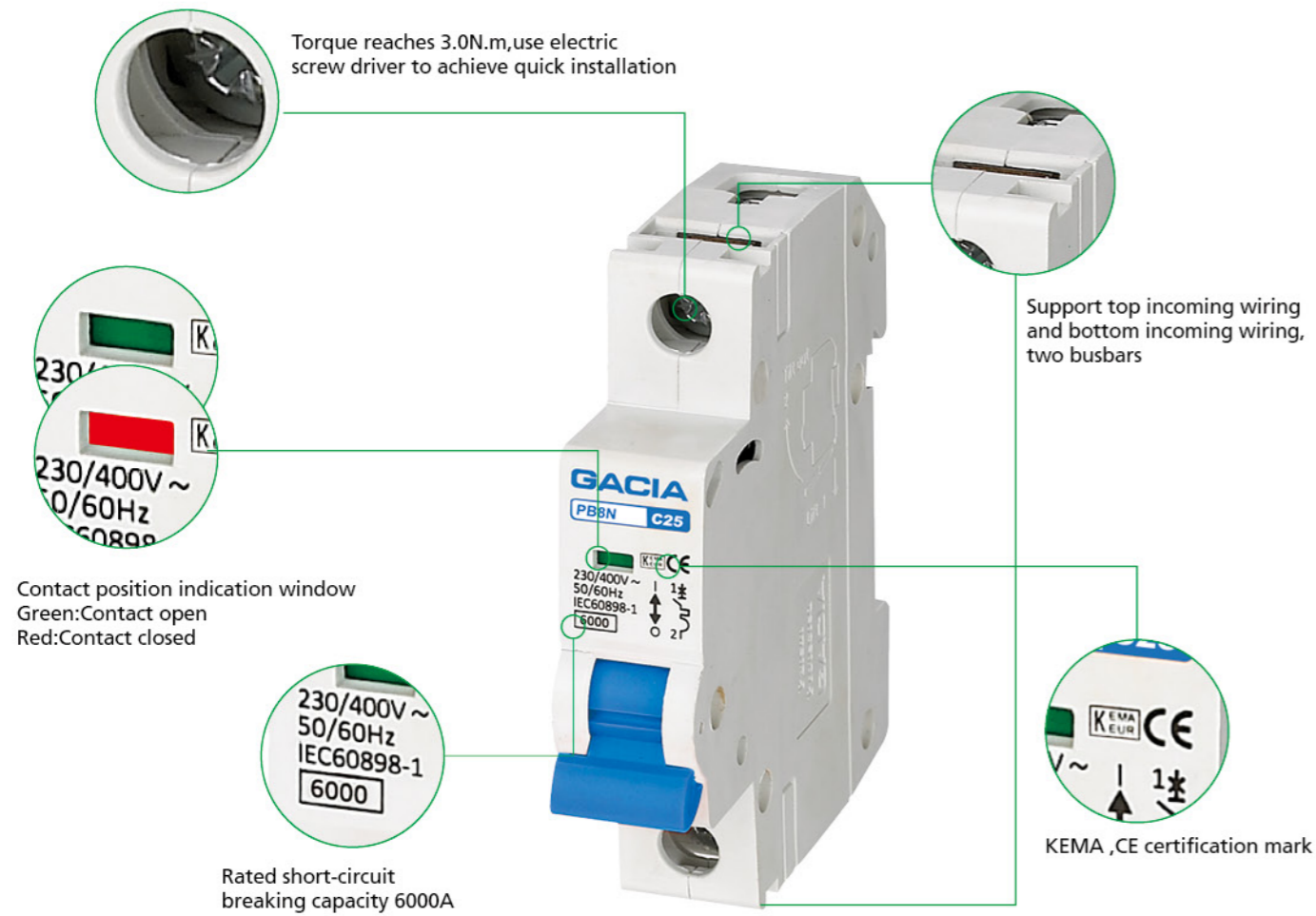

Normal Working Conditions and Installation Conditions

- ◆ Ambient Temperature: $-5^{\circ}\text{C} \sim +40^{\circ}\text{C}$, it's average over a period of 24 hours does not exceed $+35^{\circ}\text{C}$.
- ◆ Height above Sea Level: $\leq 2000\text{m}$
- ◆ Atmospheric Condition:
When the maximum temperature is $+40^{\circ}\text{C}$, the relative humidity of the air is not exceed 50%, and it has higher humidity at lower temperature. The maximum monthly relative humidity is 90%, and the lowest temperature is $+20^{\circ}\text{C}$. Additionally, a frost might be present, with the temperature change.
Pollution Degree: 2
Installation Conditions:
- ◆ Installation Category and Type: Installation category is II or III, and the installation type adopts standard steel guide rail installation (TH35-7.5).
The circuit breaker shall be installed vertically, and the upward position of the handle shall be connected to the power.
The installation should be free from obvious impact and vibration, corrosive and explosive gases.

Characteristics Curve

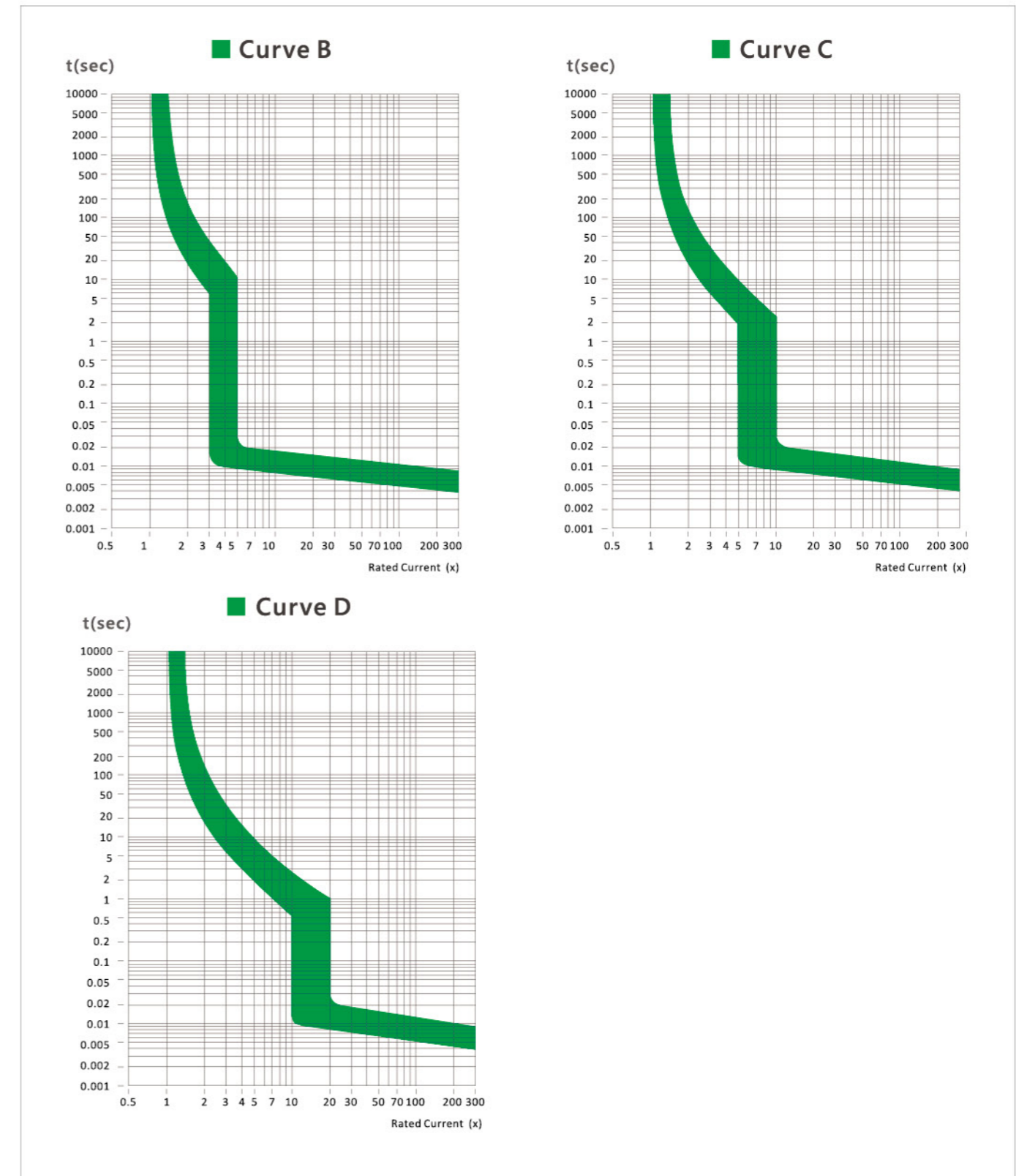

Time-current operating characteristics

Test	Type	Test current	Initial condition	Limits of tripping or non-tripping time	Result to be obtained	Remarks
a	B, C, D	$1,13 I_n$	Cold ^a	$t \leq 1h$ (for $I_n \leq 63A$) $t \leq 2h$ (for $I_n > 63A$)	No tripping	
b	B, C, D	$1,45 I_n$	Immediately following test a	$t < 1h$ (for $I_n \leq 63A$) $t < 2h$ (for $I_n > 63A$)	Tripping	Current steadily increased within 5 s
c	B, C, D	$2,55 I_n$	Cold ^a	$1s < t < 60s$ (for $I_n \leq 32A$) $1s < t < 120s$ (for $I_n > 32A$)	Tripping	
d	B C D	$3 I_n$ $5 I_n$ $10 I_n$	Cold ^a	$t \leq 0,1s$	No Tripping	Current established by closing an auxiliary switch
e	B C D	$5 I_n$ $10 I_n$ $20 I_n$ ^b	Cold ^a	$t < 0,1s$	Tripping	Current established by closing an auxiliary switch

NOTE An additional test, intermediate between c and d, is under consideration for circuit-breakers of type D.

^a The term "cold" means without previous loading, at the reference calibration temperature.

^b $50 I_n$ for special cases.

Dimensions

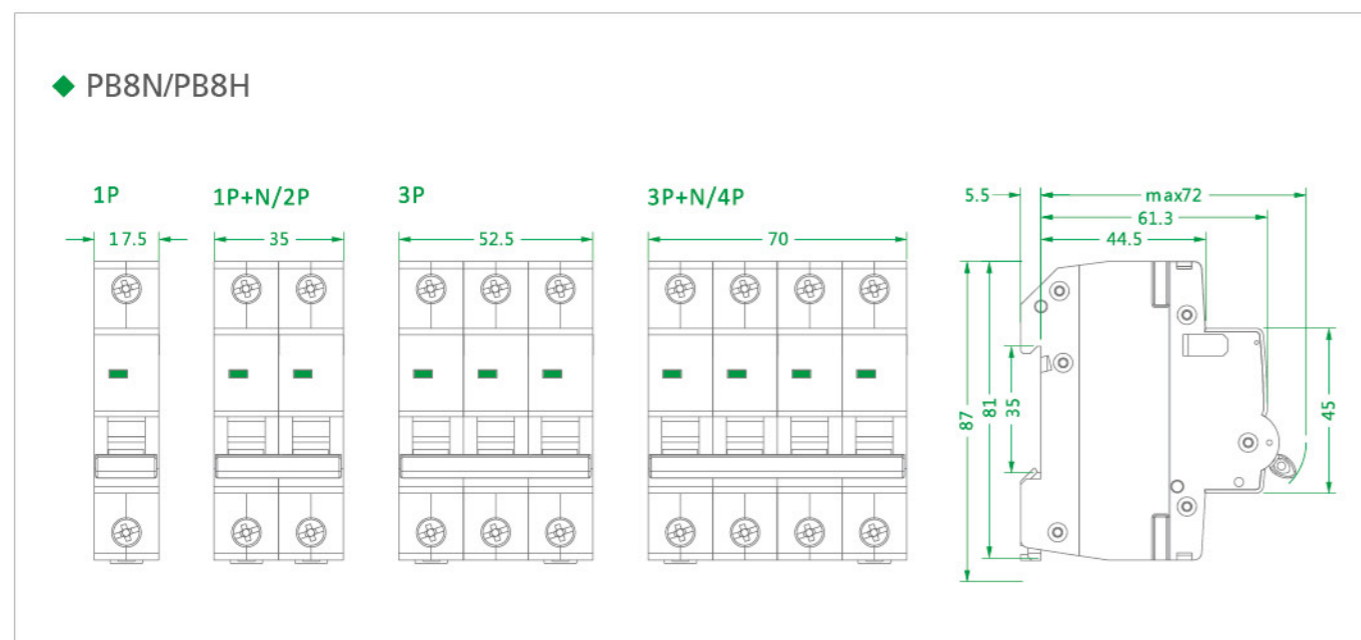



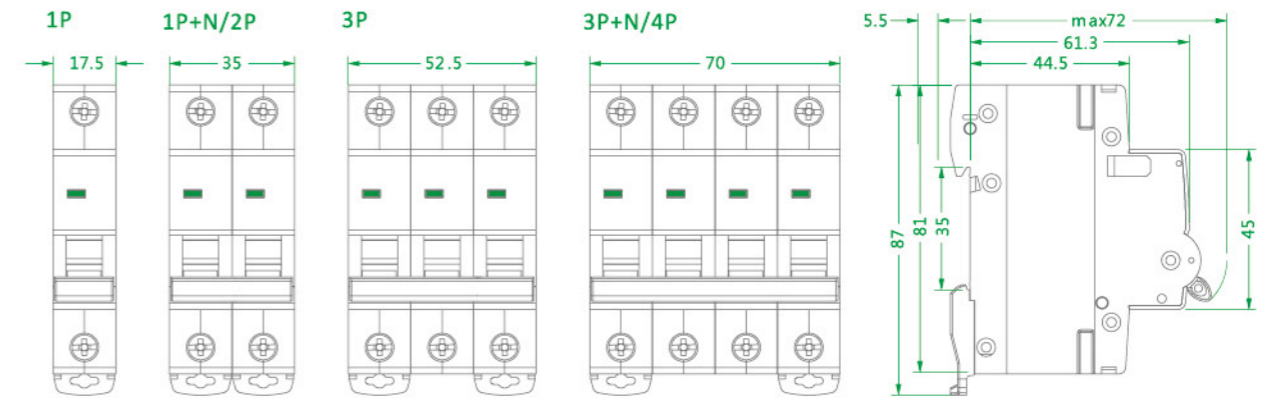

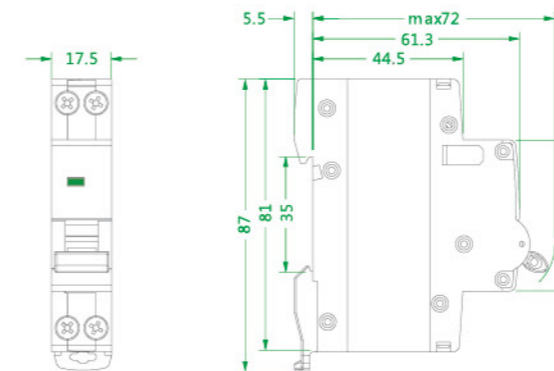

◆ PB8NN/PB8HN



◆ PN8N/PN8H



Model	PL8HM	PL8HE	PL8NT
IEC/EN 61009-1			
Poles	1P+N	1P+N	1P+N
Certification			
Electrical Specification			
Rated current(A)	In	6-32	6-32
Rated frequency(Hz)		50/60	50/60
Rated working voltage(V)	Ue	230	230
Rated insulated voltage(V)	Ui	400	400
Rated impulse withstand voltage(kV)	Uimp	4	4
Rated short-circuit breaking capacity(KA)	Ics	6	6
Rated Residual current(mA)	IΔn	30,100,300	30,100,300
Thermo-magnetic release characteristic		B,C,D	B,C
Residual current protection type		Electromagnetic	Electronic
Residual current working type		A,AC	A,AC
Rated residual making and breaking capacity(A) Im/I Δm		500	500
Dielectric test voltage(kV)		2.5	
Service life (O-C)	Mechanical Standard value	4000	4000
	Electrical Standard value	2000	2000
Control And Indication			
Shunt release(SHT)		■	
Undervoltage release(UVT)		■	
Auxiliary contact(AUX)		■	
Alarm contact(ALT)		■	
Contact position indicator		■	
Fault indication		-	
Connection And Installation			
Ambient temperature(with daily average≤35℃)		-5℃ ~+40℃	
Protection degree	ALL sides	IP40	
	Connection terminal	IP20	
Wire(mm ²)		1-16	1-6
busbar(mm ²)		16	-
Mounting		Cable/Busbar	Cable
Pollution degree		2	
Reference temperature for setting of thermal element(℃)		30	
Storage temperature(℃)		-25℃ ~+70℃	
Tightening torque		3.0	2.0
Connection		Top and bottom	Top
Dimensions(mm) (WxHxL)	a(2P)	35.7	17.7
	b(2P)	87	87
	c(2P)	77.5	77.5
Weight(kg)	2P	0.18	0.11

■ Default □ Optional - None

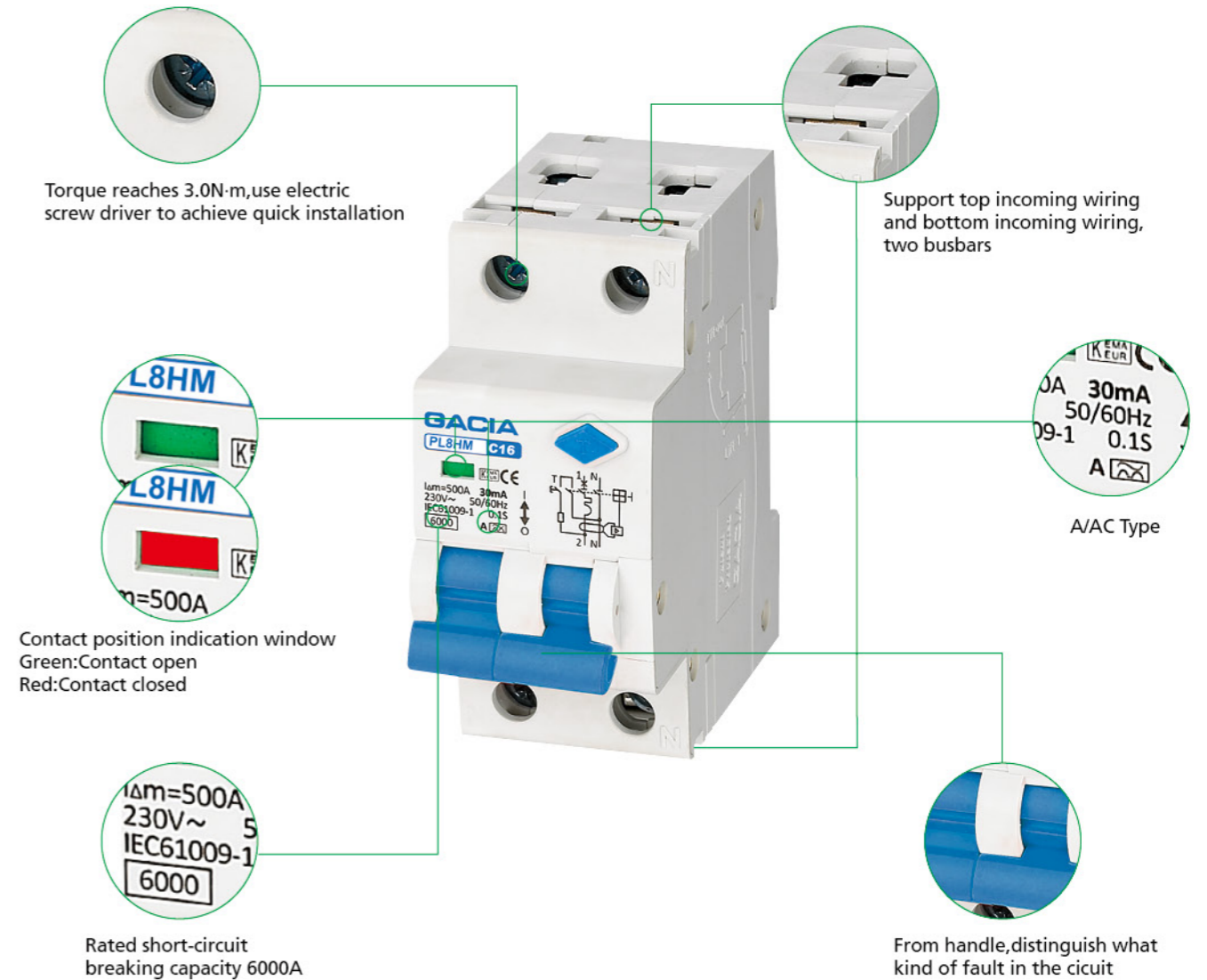

Normal Working Conditions and Installation Conditions

- ◆ Ambient Temperature: -5℃ ~+40℃ .
- ◆ Height above Sea Level: ≤ 2000m
- ◆ Installation Category: II, III
- ◆ Pollution Degree: 2
- ◆ The installation type adopts standard steel guide rail installation (TH35-7.5).
- ◆ Installation Conditions: The external magnetic field of the installation site shall not exceed 5 times of the earth's magnetic field in any direction. When over voltage residual current moves, the circuit breaker shall be installed vertically, and the upward position of the handle shall be connected to the power. The installation should be free from obvious impact and vibration.
- ◆ Mode of Connection: Use screws to press the wiring.

Characteristics Curve

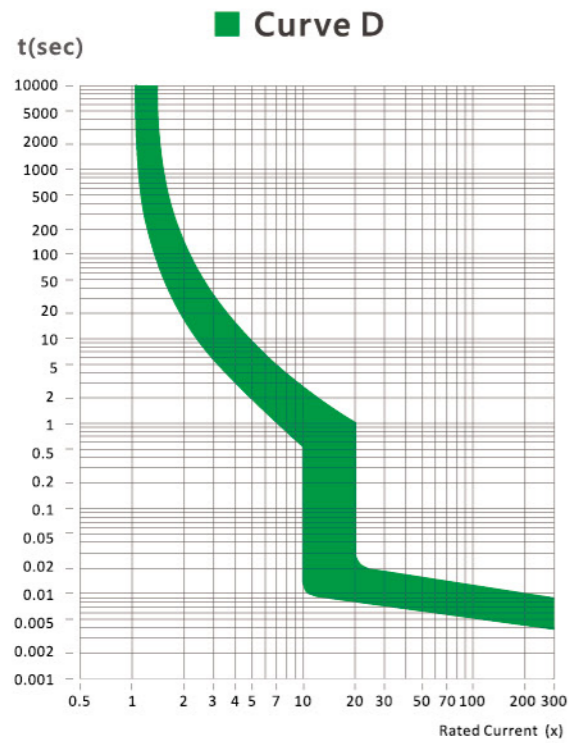
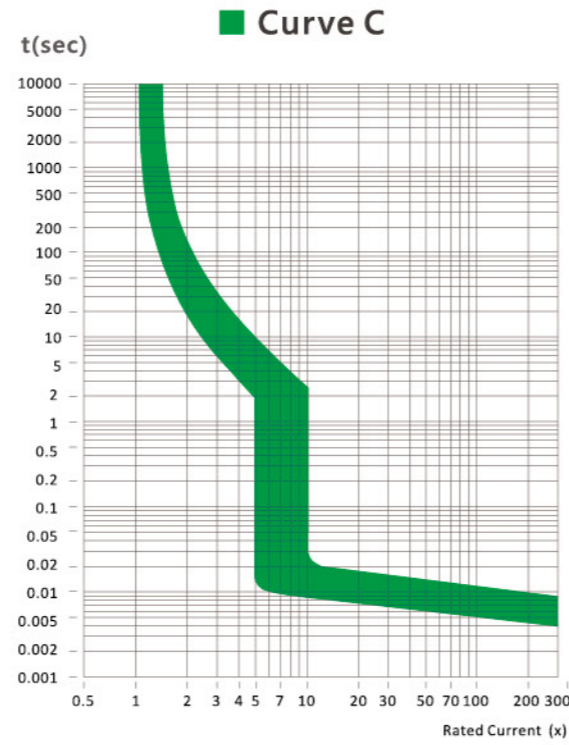
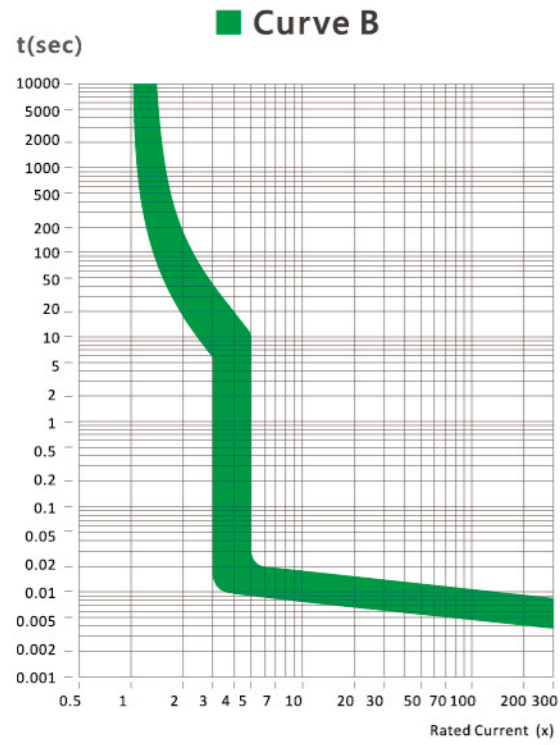

Dimensions

◆ PL8HM/PL8HE

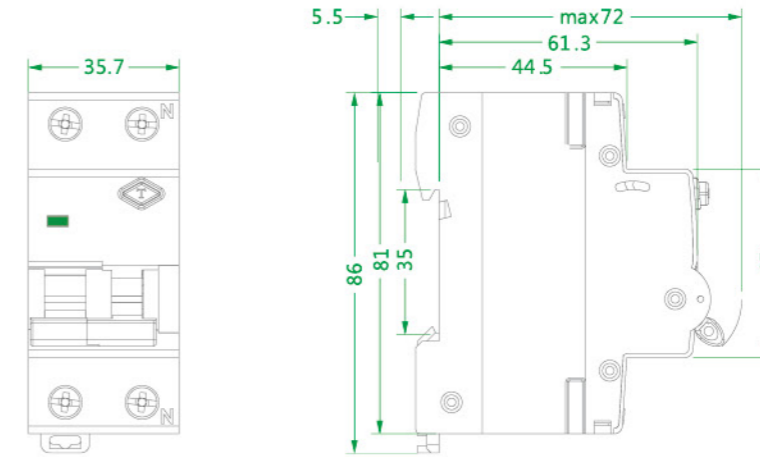

◆ PL8NT

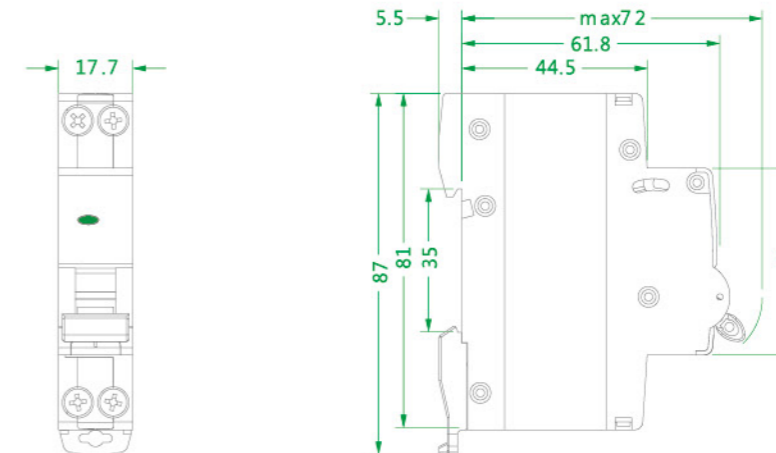

Model		PR8NM	PR8HM	PR8NE	PR8HE
IEC/EN 61008-1					
Poles		2P,4P	2P,4P	2P,4P	2P,4P
Certification					
Electrical Specification					
Rated current(A)	In	16-100A	16-100A	16-100A	16-100A
Rated working voltage(V)	ue	2P:230,4P:400	2P:230,4P:400	2P:230,4P:400	2P:230,4P:400
Rated insulated voltage(V)	ui	500	500	500	500
Impulse withstand voltage(kV)	uimp	6	6	6	6
Rated conditional short-circuit current(kA)	I _{nc}	6	10	6	10
Rated Residual current(mA)	I _{Δn}	10,30,100,300	10,30,100,300	10,30,100,300	10,30,100,300
Rated Residual making and breaking capacity(A)	I _{Δm}	1000	1000	1000	1000
Residual current working type		AC,AC+S,A,A+S	AC,AC+S,A,A+S	AC,AC+S,A	AC,AC+S,A
Residual current Protection type		Electromagnetic	Electromagnetic	Electronic	Electronic
Dielectric test voltage(kV)		2.5			
Service life (O-C)	Mechanical Standard value	4000			
	Electrical Standard value	2000			
Control And Indication					
Shunt release(SHT)		-			
Undervoltage release(UVT)		-			
Auxiliary contact(AUX)		-			
Alarm contact(ALT)		-			
Contact position indicator		-			
Fault indication		□			
Connection And Installation					
Ambient temperature(with daily average≤35℃)		-5℃ ~+40℃			
Protection degree	ALL sides	IP40			
	Connection terminal	IP20			
Wire(mm ²)		35			
busbar(mm ²)		35			
Mounting		Cable/Busbar			
Pollution degree		30			
Reference temperature for setting of thermal element(℃)		2			
Storage temperature(℃)		-25℃ ~+70℃			
Tightening torque		Top and bottom	Top and bottom	Top	Top
Connection		36/72			
Dimensions(mm) (WxHxL)	a(2P)	87/87			
	b(2P)	79.5/79.5			
	c(2P)	0.17			
Weight(kg)		2P	0.34		

■ Default □ Optional - None

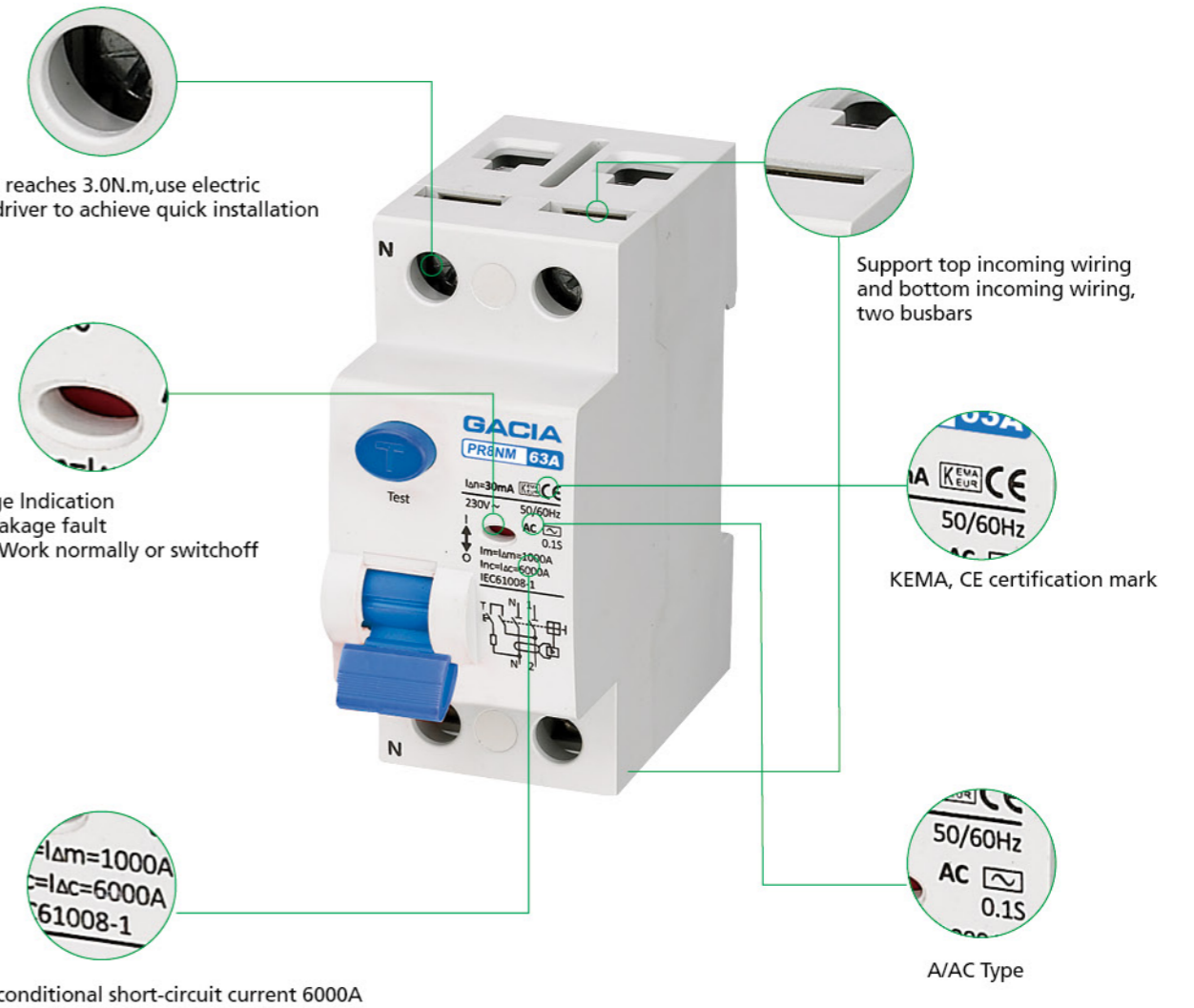

Normal Working Conditions and Installation Conditions

- ◆ Ambient Temperature: -5℃ ~+40℃ .
- ◆ Height above Sea Level: ≤ 2000m
- ◆ Installation Category: II, III
- ◆ Pollution Degree: 2
- ◆ The installation type adopts standard steel guide rail installation (TH35-7.5).
- ◆ Installation Conditions: The external magnetic field of the installation site shall not exceed 5 times of the earth's magnetic field in any direction. When over voltage residual current moves, the circuit breaker shall be installed vertically, and the upward position of the handle shall be connected to the power. The installation should be free from obvious impact and vibration.
- ◆ Mode of Connection: Use screws to press the wiring.

Dimensions

◆ PR8NM/PR8HM/PR8NE/PR8HE

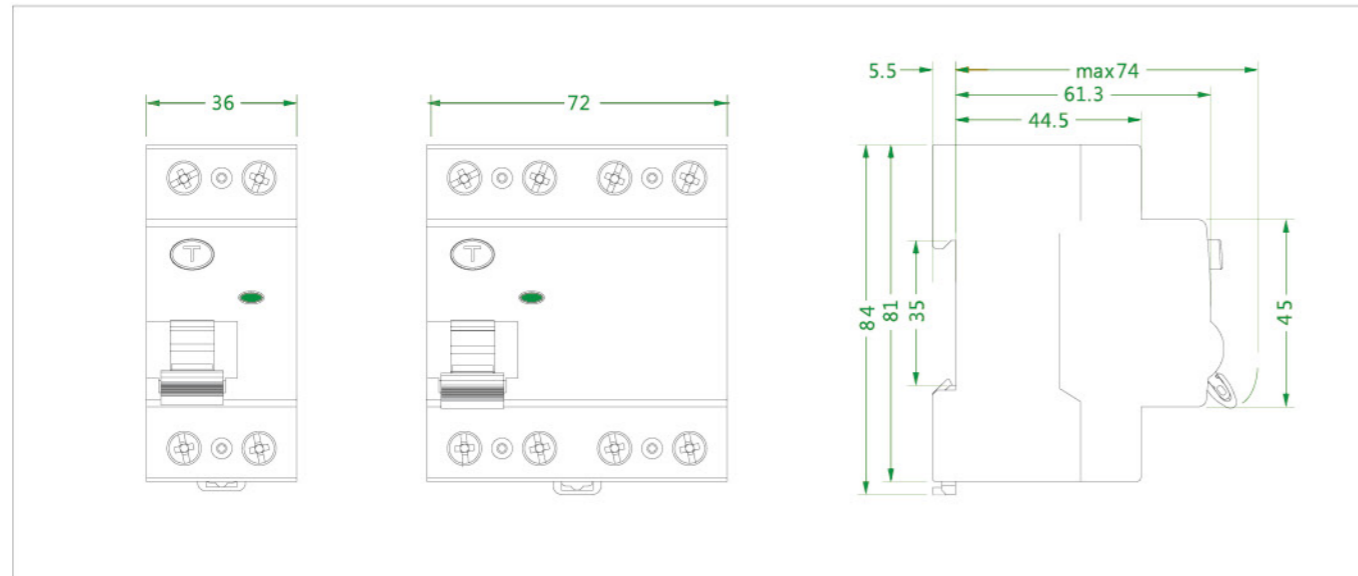

The combination of electrical accessory devices.



Remote indicating accessories

AUX auxiliary contact

Function: indicate the open and close state of circuit breaker.
Application: distant indication of circuit breaker state.

ALT Alarming contact

Function: send signal at the time of fault tripping of circuit breaker.
On the front panel, there is mechanical indication which can indicate fault tripping.

AUX+ALT/AUX double switching contact

Function: two switching contact can indicate the "open" or "closed" state of circuit breaker with OFF. Indicate the failure trip of circuit breaker.
Application: two loops Up :AUX
Down: ALT and AUX
Select functions with the rotating switch on the right.
Selecting function indicated on the front cover of the device.
Be a red indicator on the front cover of the device when failure trips.

Tripping accessories

Red tripping indicator on the front cover of the device.

SHT shunt release, SHTA shunt release+aux

Function: when it gets signal, it triggers the circuit breaker to trip.
SHTA: it includes a condition indication contact to indicate the on/off state of circuit breakers.
Application: distant control can achieve emergency breaking.
Distant indication of circuit breaker state.

UVT under-voltage release

Function: when power voltage lowers(35%~70%Un), it makes circuit breaker trip; when power is not supplied normally, it prevents circuit breaker from reconnecting to the circuit.
0.25 time delay prevents the temporary lowering of voltage from causing mistrip.
Application: preventing machine from restarting without control signal, ensuring safety.

OVT over-voltage release

Function: monitor voltage between phase line and neutral line. When voltage rises(for example, neutral line is broken), it triggers circuit breakers to trip.
Rated tripping voltage range: 280vac +/-5%.
Application: preventing over-voltage from damaging circuit and equipment.

OUVT Over&under-voltage release

Function: it has function of over-voltage release, and function of making circuit breaker trip when power voltage lowers.
Rated tripping voltage range: 280vac +/-5%.
Rated under-voltage tripping range: 55 ~160v.
Application: preventing over-voltage and under-voltage from damaging circuit and equipment.



Model	Voltage Ue	Working current	Contact Number
Auxiliary contac			
	AC 230/400V	230V AC 6A	1NO/NC
	DC 120V	400V AC 3A	
		120V DC 1A	

Alarm contact			
	AC 230/400V	230V AC 6A	1NO/NC
	DC 120V	400V AC 3A	
		120V DC 1A	

Shunt release					
	AC 230/400V	48V	12/24V	-	-
	DC 120V	48V	12/24V	-	-

Auxiliary contac					
	AC 230/400V	48V	12/24V	230V AC 6A	1NO/NC
	DC 120V	48V	12/24V	400V AC 3A	
				120V DC 1A	

Model	Voltage Ue	Working current	Contact Number	
Under-Volatage Release				
	AC 230V	230V	-	-
	DC -	-	-	-

OverVolatage Release				
	AC 230V	230V	-	-
	DC -	-	-	-

Over&under-voltage release				
	AC 230V	230V	-	-
	DC -	-	-	-